



LAMILUX daylight systems - active energy management for passive houses





LAMILUX CI System Glass architecture PR60_{energysave}

Best-in-class passive house standard with freedom of design

LAMILUX CI System glass architecture PR60_{energysave} redefines energy standards in glazed roof constructions: this is the first sloped glazing world-wide to achieve certification in the highest efficiency class in terms of passive house criteria by the Passivhaus-Institut, Darmstadt, Germany.

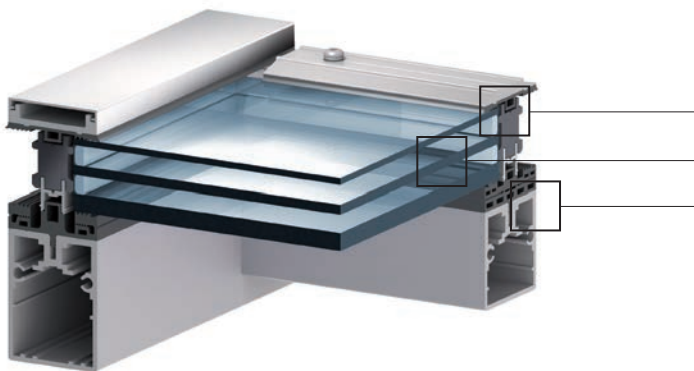
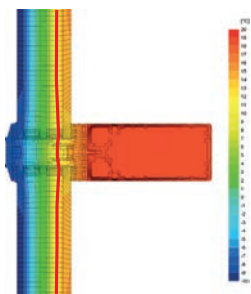



LAMILUX
CI-SYSTEME

"For the first time, this gives energy- and cost-conscious architects and designers a glazed roof system solution that is not only suitable for passive houses, but also meets the highest passive house efficiency class, phA."

(Dr.-Ing. Benjamim Krick, Passivhaus-Institut Darmstadt)

- highest passive house efficiency class – phA advanced component
- heat transfer coefficient U_{CWI} 0.82 W/(m²K)
- no condensate and mould formation thanks to stable f_{RSI} value of 0.79
- low heat loss and high solar heat gain ($\psi_{opak} \leq 0.110$ W/(mK))

NEW: Optimised insulation core

3x insulating glazing with "warm edge" as standard

NEW: Optimised sealing system





LAMILUX CI System Glass element FE_{energysave}

Skylight to the highest energy efficiency standard

The energy quality of building products is the measure of all things in modern building. The passive house demands the highest standard – and the LAMILUX CI System glass element FE_{energysave} is the world's first skylight to be certified to this energy-efficiency level by the Passivhaus-Institut, Darmstadt, Germany.

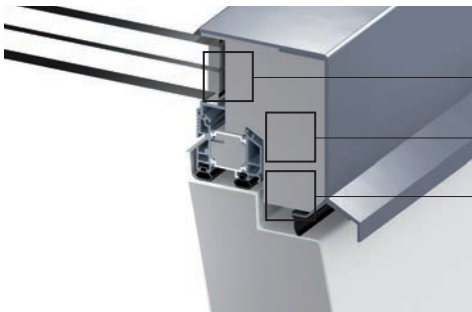
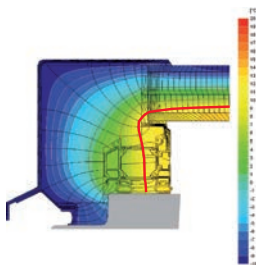



LAMILUX
CI-SYSTEME

The compact daylight element for flat roofs has achieved the highest efficiency rating following its classification as a phA advanced component. *"This skylight represents excellent energy quality."*

(quote Passivhaus-Institut, Darmstadt, Germany)

- highest passive house efficiency class – phA advanced component
- heat transfer coefficient U_{SL} 0.84 W/(m²K)
- Minimised condensate risk thanks to stable f_{RSI} value of 0,73
- low heat loss and high solar heat gain ($\psi_{opak} \leq 0.110$ W/(mK))

NEW: "Warm edge" with Superspacer
in serial triple glazing

NEW: Optimised insulation core

NEW: triple layer sealing system





LAMILUX CI System Glass element FE_{energysave+}

Certified daylight system for the "cold" climatic zone

Even higher energy quality and passive house certification in the top phA classification attested for the LAMILUX CI-System glass element FE_{energysave+}. The daylight system meets the criteria for the "cold" climate zone and is thus the world's first skylight to be suitable for passive houses in Scandinavia and many regions of Austria, Switzerland and Eastern Europe.

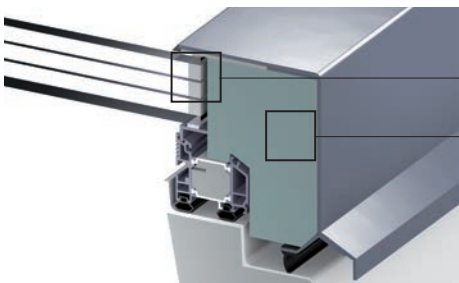
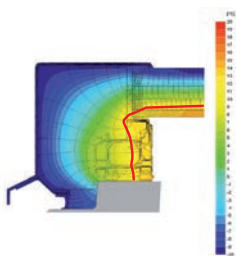



LAMILUX
CI-SYSTEME

"LAMILUX is again pioneering with this product: The LAMILUX CI-System glass element FEnergysave+ is the first passive house certified component to achieve certification for the "cold" zone across all product lines."

(Andreas Rudolph, Development Engineer with LAMILUX)

- serial 4-pane ISO glazing with Krypton fill
- highest passive house efficiency class – phA advanced component
- heat transfer coefficient U_{SL} 0.68 W/(m²K)
- Minimised condensate risk thanks to stable f_{RSI} value of 0,76
- low heat loss and high solar heat gains ($\psi_{opak} \leq 0.110$ W/(mK))

NEW: "Warm edge" with Superspacer
in serial 4x glazing

NEW: Optimum insulating core material



Active energy management with daylight systems

Passive house certifications in line with climate zones

Extending in east to west direction, the earth is divided into seven climate zones – from "very hot" (7) to "Arctic cold" (1). Category 2 is the "cold" zone, and category 3 the "cool-moderate" zone.







In the **"cold" climate zone**, the LAMILUX CI System glass element FE_{energysave}⁺ is the **first skylight worldwide to** achieve passive house certification in the **highest efficiency class**. For example, it is suitable for passive houses in the cities of Reykjavik, Oslo, Stockholm, Warsaw, Kiev, Moscow, Yekaterinburg, Winnipeg, Quebec, Halifax und Calgary.



The two skylights CI-System glazed architecture PR-60_{energysave} and LAMILUX CI-System glass element FE_{energysave} are certified for the **"cool-moderate" climate zone**. This zone includes cities such as London, Paris, Berlin, Vienna, Zagreb, Budapest, Sofia, Washington, New York, Montreal, Kansas City, Shanghai, Peking, Seoul and Tokyo.

Climate zones

-  Arctic
-  cold
-  cool-moderate
-  warm-moderate





LAMILUX CI-SYSTEME



DOMELIGHT F100



CONTINUOUS ROOFLIGHT B



LIGHT PANEL



GLASS ARCHITECTURE PR 60



CONTROL TECHNOLOGY



FRESH AIR SUPPLY DEVICES



GLASS ELEMENT F



CONTINUOUS ROOFLIGHT S



BUILDING UPGRADES



SMOKE AND HEAT EXHAUST
VENTILATION SYSTEMS



PHOTOVOLTAICS



FIBRE-REINFORCED
COMPOSITES

The technical data printed in this brochure was accurate when this brochure went to press and is subject to change without notice. Our technical specifications are based on calculations and supplier specifications, or have been determined by independent testing authorities within the scope of applicable standards. Thermal transmission coefficients for our composite glazing were calculated using the finite element method with reference values in accordance with DIN EN 673 for insulated glass. Based on empirical values and specific characteristics of the plastics, a temperature vector of 15 K was defined as the vector between the outer surfaces of the material. Functional values refer to test specimens and the dimensions used in testing only. We cannot provide any further guarantees for technical specifications. This particularly applies to changes in installation locations, or if dimensions are re-measured on site.



LAMILUX Heinrich Strunz GmbH

Zehstraße 2 · Postfach 1540 · 95111 Rehau · Tel.: +49 (0) 92 83 / 5 95-0 · Fax +49 (0) 92 83 / 5 95-29 0
E-Mail: information@lamilux.de · www.lamilux.de

